

Description

CMB23A03-W100

Chinasound Mechanical Buzzer 23mm length, type A(=16mm width,15mm height) , 03VDC rated voltage – Wire length 100mm

- ◆ Small size
- ◆ Low Frequency

Picture



Characteristics

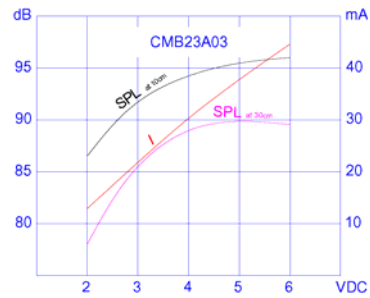

Specification

Rated Voltage	3 VDC
Operating Voltage	2 ~ 6 VDC
Rated Current	35 mA max. at 3 VDC
Sound Output	83 dB min. at 3 VDC, 10cm
Operating Temperature	-20°C to +50°C
Storage Temperature	-20°C to +50°C
Termination	Wire, UL1571 AWG28#, Red(+); Black(-) 100mm length
Construction Materials	Maximum of 9.8N load pull test, applied to each terminal in axial direction for 10 seconds Plastic, ABS 757 Spring Steel
Weight (Typical)	8.4 g
Reliability	At 3 VDC in room temperature continuously for 50 hours no function at +50+/-2°C for 96 hours, function at +50+/-2°C for 96 hours, no function at -20+/-2°C for 96 hours, function at -20+/-2°C for 96 hours, +40+/-2°C, 90-95%RH for 96 hours -20+/-2°C, 30min→+20°C,15min,→+50+/-2°C, 30min→+20°C,15min, 5 cycles 1.5mm with 10 to 50Hz of vibration frequency to each of 3 perpendicular direction for 2 hrs 98m/s ² (=10g) shock for each mutually perpendicular directions, half sine wave, 3 times each
	For a period of one (1) year from date of manufacture under normal operations
Warranty	* All specifications must be satisfied after the test (Recovery:2 to 4 hrs of recovery under the standard condition after the removal from test chamber).

Dimensions (Unit: mm)

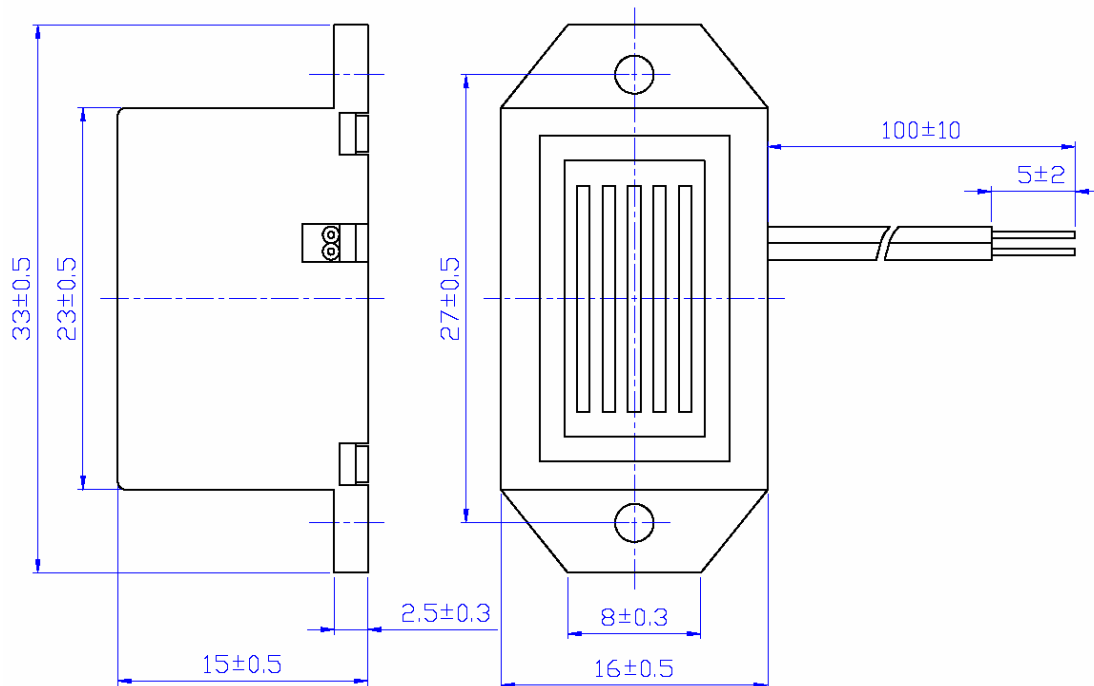

All specifications are subject to change without notice